

CARA FRONTAL

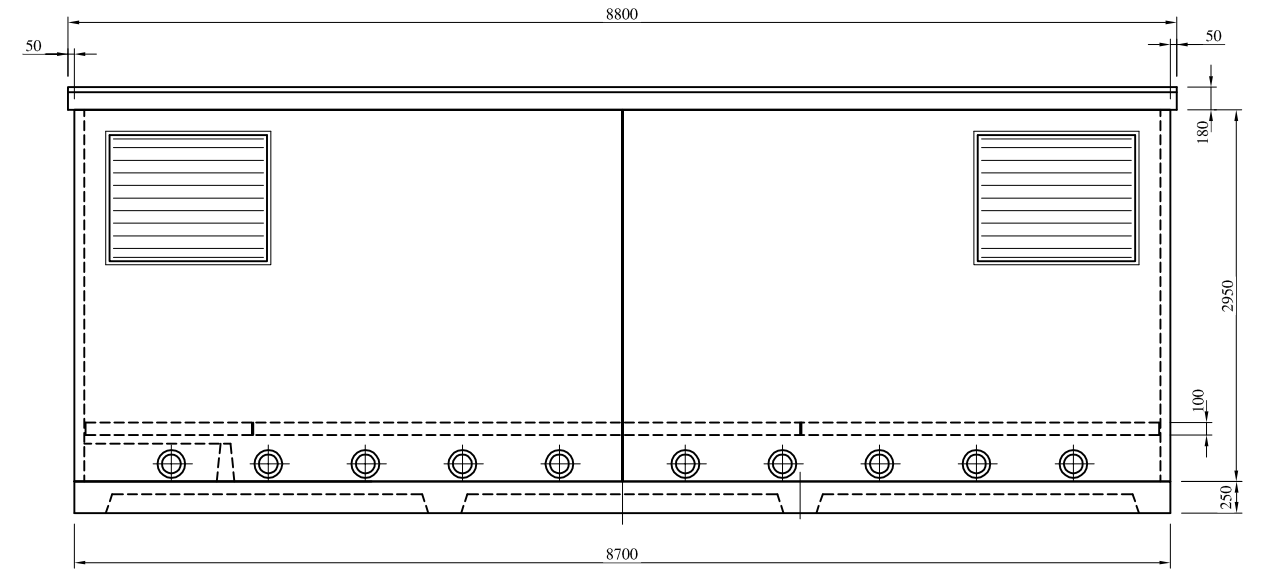

CARA POSTERIOR

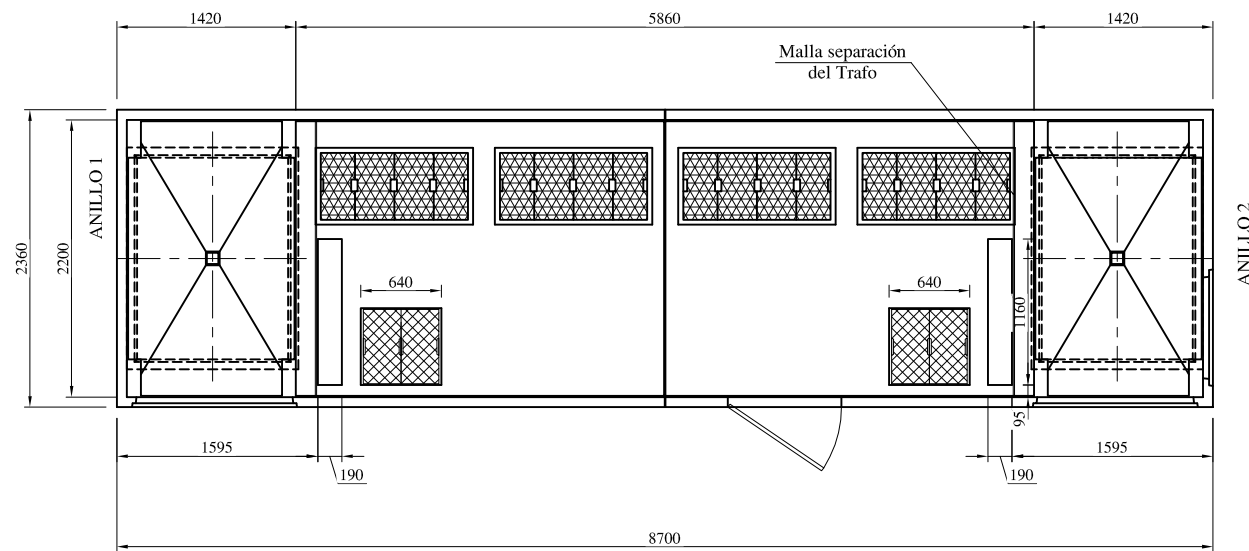

SECCION A-A
(LOSA SUPERIOR)

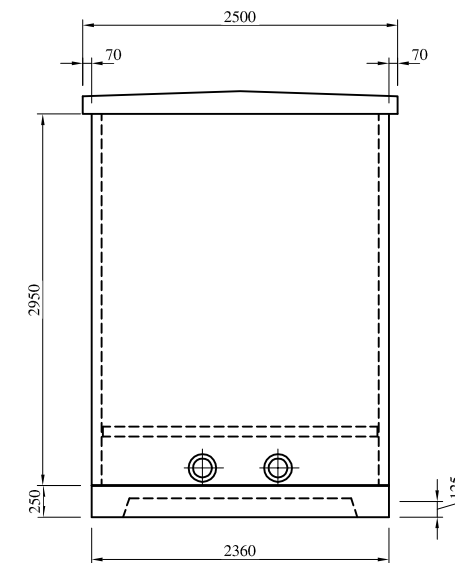

CARA IZQUIERDA

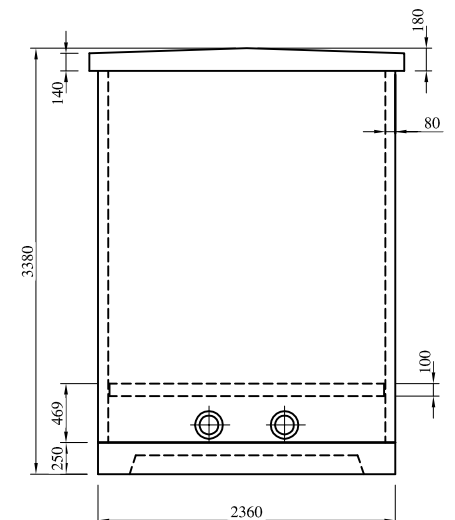

CARA DERECHA



postes nervión, s.a.

D						E					
B						C					
INICIAL	00-00-00		A.Z.L.	I.U.R.	R.L.H.	A					
REVISIÓN	FECHA	DESCRIPCIÓN	DIBUJADO	REVISADO	APROBADO	REVISIÓN	FECHA	DESCRIPCIÓN	DIBUJADO	REVISADO	APROBADO



PROYECTO
PNCT4-M/2T

DESCRIPCIÓN
Conjunto

ESCALA A3	N° PLANO
1/60	000
REVISIÓN	PROYECTO
0	-/-